

thermoMETER CS



thermoMETER CS

This self contained, non contact infrared temperature sensor requires no external signal condition controller, which makes it an ideal product for OEM applications. It is fully programmable via the digital interface and provides an accurate temperature reading via the analog or digital interface.

- Measuring range from -40 to 400°C
- Robust precision silicon optics with AR coating
- Integrated controller with LED alarm indicator and smart electronic sighting support, selfdiagnostic or temperature code indication
- Up to 80°C ambient temperature without cooling
- Short circuit and reverse polarity protection
- Field programmable
- Adjustable emissivity
- Fast response time: 25ms
- Analog outputs with digital interfaces option
- Wide input range: 5 - 30V DC
- Please note: available from 10 pieces

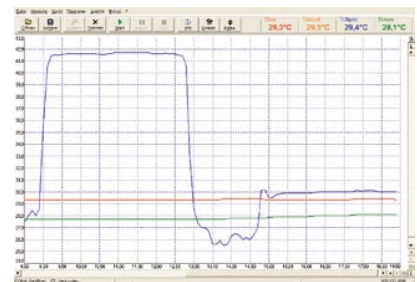

Software CompactConnect

- Display, graphic charting and recording of temperature readings
- Easy system configuration and sensor calibration
- Sophisticated signal processing features
- Programming of input and output channels

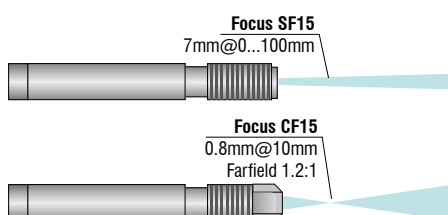

Optical specifications thermoMETER CS

□ = smallest spot size (mm)

Standard Focus optics										
SF15	15:1	7	8	13	20	27	33	40	47	53
distance in mm										
		0	100	200	300	400	500	600	700	800
Close Focus optics (CF lense optional available)										
CF15	15:1	7	5	0.8	5	11	16	21	27	32
distance in mm										
		0	5	10	15	20	25	30	35	40

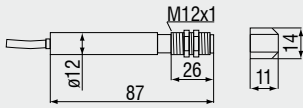
Product identification

CS - SF15 - C1

- Cable length [1 m (standard) / 3 m / 8 m / 15 m]
- Focus [SF]
- thermoMETER CS

Model	CS-SF15-C1
Optical resolution	15:1
Temperature range ¹	-40 to 400°C
Spectral range	8 to 14µm
System accuracy ²	±1.5% or ±1.5°C
Repeatability ²	±0.75% or ±0.75°C
Temperature resolution ³	±0.1°C
Response time	25ms to 999s (90%), adjustable
Emissivity/gain	0.100 to 1.100 (adjustable via 0 to 5V DC input or software)
Transmissivity/gain ¹	0.100 to 1.100
Signal processing ¹	peak hold, valley hold, average; extended hold function with threshold and hysteresis
Certificate of calibration	optional
Outputs/analog	0 to 5V or 0 to 10V 1/10/100 mV/ °C
Outputs/digital	optional USB or Alarm 0-30V / 500mA (open collector)
LED functions	alarm indication, automatic aiming support, self diagnostic, temperature indication (via temp. code)
Inputs	programmable functional input for external emissivity/ambient temperature adjustment (0 to 5VDC), hold function or RS232 / USB (optional) communication
Cable length	1m (standard), 3m, 8m, 15m
Power supply	4mA (without LED), 10mA (5 to 30VDC)
Environmental rating	IP 63 (NEMA-4)
Ambient temperature	-20°C to 80°C
Storage temperature	-20°C to 85°C
Relative humidity	10 to 95%, non condensing
Vibration	IEC 68-2-6: 3 G, 11 to 200Hz, any axis
Shock	IEC 68-2-27: 50 G, 11ms, any axis
Weight	58g

¹ adjustable via software

² ± ambient temperature: 23 ±5°C; whichever is greater; object temperature ≥0°C

³ temperature of the object <100°C and time constant >0.2s

Accessories page 64 - 65

- ▶ CF lense
- ▶ Protective window
- ▶ Mounting bracket / Mounting bolt
- ▶ Air purge collar
- ▶ Right angle mirror
- ▶ Software CompactConnect
- ▶ USB Kit

Dimensions and software thermoMETER CS / CSmicro / CX

CSLaser

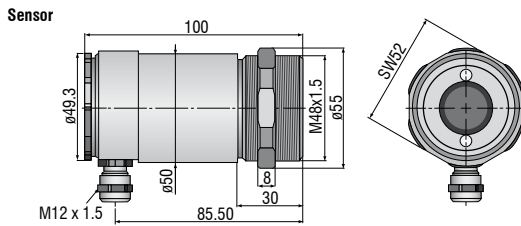

CS

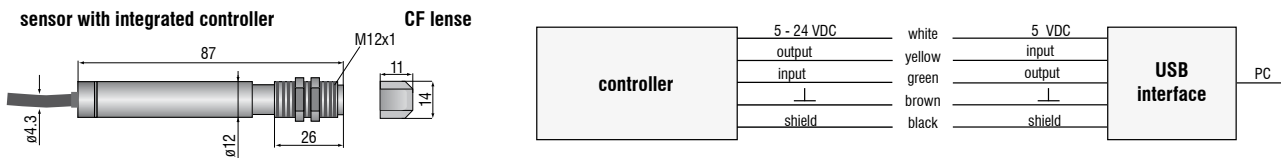

CSmicro

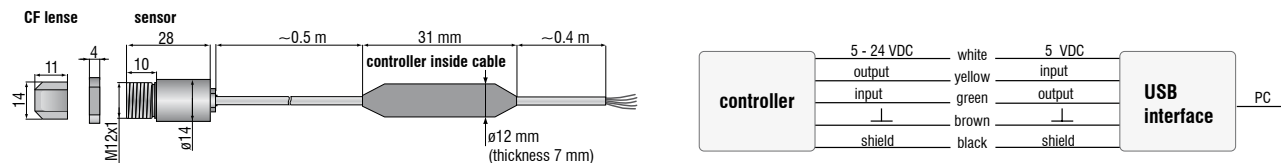

CX

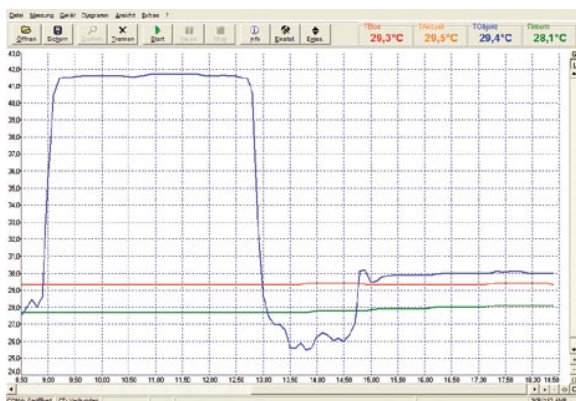
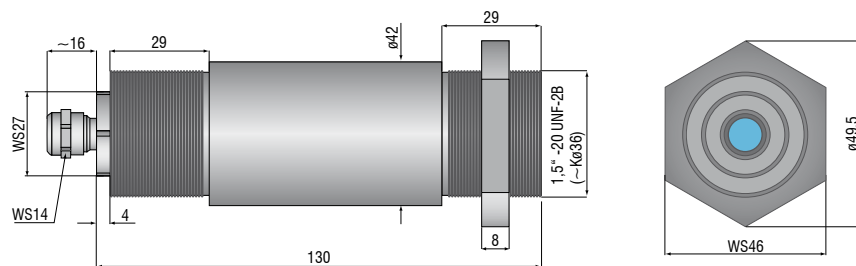

Software CompactConnect

- Display, graphic charting and recording of temperature readings
- Easy system configuration and sensor calibration
- Sophisticated signal processing features
- Programming of input and output channels

System requirements

- Windows XP, Vista, Windows 7
- USB 2.0
- Hard disc min. 30 MByte
- min. 128 MByte RAM
- CD-ROM drive

Accessories thermoMETER CS / CSmicro / CX

Mechanical accessories CS / CSmicro

Art. No.	Model	Description
2970279	TM-FB-CS	Mounting bracket, fixed
2970280	TM-AB-CS	Mounting bracket, adjustable
2970281	TM-MB-CS	Mounting bolt with M12x1 thread
2970282	TM-MG-CS	Mounting fork, adjustable in 2 axes, with thread M12x1
2970283	TM-AP-CS	Air purge collar for 10:1 sensors
2970284	TM-APL-CS	Air purge collar, laminar
2970285	TM-APLCF-CS	Air purge collar, laminar, integrated CF-lens
2970286	TM-RAM-CS	Right angle mirror for 90°C measurements
2970287	TM-USBK-CS	USB interface kit incl. software Compact-Connect

Optical accessories CS / CSmicro

2970277	TM-CF-CS	CF-Lens for CS series
2970278	TM-PW-CS	Protective window for CS series
	TM-CFH-CS	CF-Lens for 1.6µm sensor
	TM-PWH-CS	Protective window for 1.6µm sensor

Calibration CS / CSmicro

2970288	TM-CERT-CS	Certificate of calibration
---------	------------	----------------------------

Mechanical accessories CX

Art. No.	Model	Description
2970307	TM-AP-CX	Air purge collar, aluminium (anodized)
2970321	TM-FB-CX	Mounting bracket, adjustable in one axis, stainless steel
2970322	TM-AB-CX	Mounting bracket, adjustable in two axes, stainless steel
2970311	TM-USBK-CX	USB-Kit: USB programming adapter, Software CompactConnect

Optical accessories CX

2970302	TM-CF-CX	CF-lens for thermoMETER CX
2970303	TM-PW-CX	Protective window for thermoMETER CX

Calibration CX

2970323	TM-CERT-CX	Certificate of calibration
---------	------------	----------------------------

Spare parts

Controller, sensors and cables also available as spare parts - please contact Micro-Epsilon

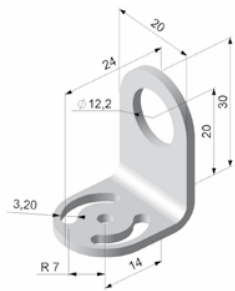

TM-FB-CS Mounting bracket, fixed

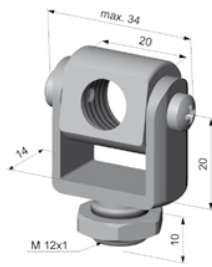

TM-MG-CS Mounting fork with M 12x1 thread adjustable in two axes

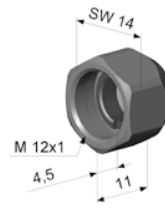

TM-CF-CS Close Focus Lens (LT sensors only)

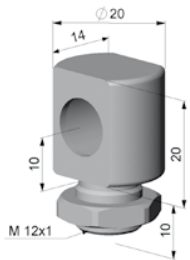

TM-MB-CS Mounting bolt with M12x1 thread adjustable

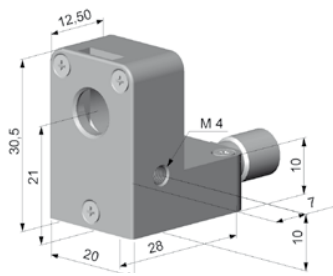

TM-APL-CS Air purge collar

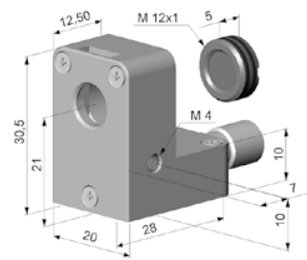

TM-APLCF-CS Air purge collar, laminar, integrated CF-lens



TM-APL-CS Laminar air purge collar and TM-MG-CS Mounting fork

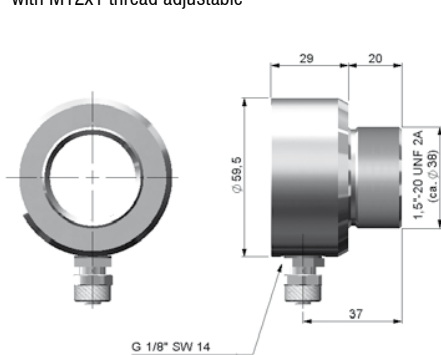

TM-AP-CX Air purge collar CX sensors

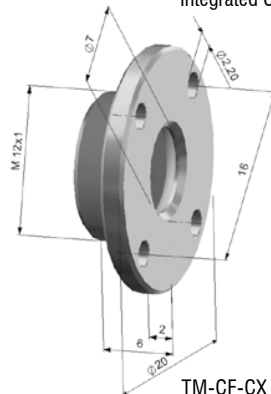

TM-CF-CX CF-Lens
TM-PW-CX Protective window

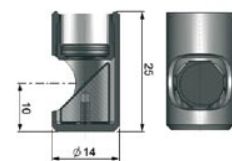

TM-RAM-CS Right angle mirror

