

thermoMETER CX



thermoMETER CX

This self contained, non contact infrared temperature sensor requires no external signal condition controller, which makes it an ideal product for OEM applications. It is fully programmable via the digital interface and provides an accurate temperature reading via the analogue or digital interface. The larger head size yields extra stable and precise measurement in harsh environments and reduces thermal shock.

- Measuring range from -30 to 900°C
- Robust precision silicon optics with AR coating
- Analogue output: 2 wire 4...20mA
- Easy two wire installation
- Wide input range: 5-30V DC
- Optical resolution of 15:1 / 22:1
- Field programmable
- Adjustable emissivity
- Response time from 150ms
- Extreme high resolution model HS with 25mK NEDT

Optical specifications thermoMETER CX

□ = smallest spot size (mm)

Standard Focus optics										
SF15	15:1	7	8	13	20	27	33	40	47	53
SF22	22:1	7	7	9	14	18	23	27	32	36
distance in mm		0	100	200	300	400	500	600	700	800
Close Focus optics										
CF15	15:1	7	5	0.8	5	11	16	21	27	32
CF22	22:1	7	4	0.6	4	8	12	16	20	24
distance in mm		0	5	10	15	20	25	30	35	40

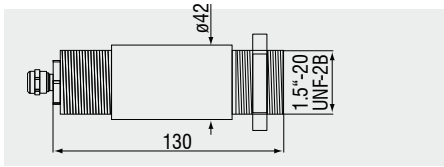
Product identification

CX - SF15 - C8

- Cable length [8 m]
- Focus [SF / CF]
- thermoMETER CX

Model	CX-SF15-C8	CX-SF22-C8
Optical resolution	15:1	22:1
Temperature range ¹	-20°C to 150°C	-30°C to 900°C
Spectral range	8 to 14 μ m	
System accuracy ²	$\pm 1\%$ or $\pm 1^\circ\text{C}$	$\pm 1\%$ or $\pm 1.4^\circ\text{C}$
Repeatability ²	$\pm 0.3\%$ or $\pm 0.3^\circ\text{C}$	$\pm 0.5\%$ or $\pm 0.7^\circ\text{C}$
Temperature resolution	0.025°C ³	0.1°C
Response time	150ms (95%)	
Emissivity/gain ¹	0.100 to 1.100	
Transmissivity ¹	0.100 to 1.100	
Signal processing ¹	peak hold, valley hold, average; extended hold function with threshold and hysteresis	
Output /analogue	4 to 20mA	
Alarm output	0 to 30V/ 500mA (open collector)	
Outputs/digital (optional)	USB	
Loop impedance	max. 1000 Ω (depends on supply voltage)	
Cable length	8m	
Power supply	5 to 30V DC	
Environmental rating	IP 65 (NEMA-4)	
Ambient temperature	-20°C to 75°C	
Storage temperature	-40°C to 85°C	
Relative humidity	10 to 95%, non condensing	
Vibration	IEC 68-2-6: 3 G, 11 to 200Hz, any axis	
Shock	IEC 68-2-27: 50 G, 11ms, any axis	
Weight	350g	

¹ adjustable via software

² \pm object temperature $> 0^\circ\text{C}$; at ambient temperature $23 \pm 5^\circ\text{C}$; whichever is greater

³ at object temperature $< 100^\circ\text{C}$ and time constant $> 0.2\text{s}$

Accessories page 60 - 61

- ▶ CF lense
- ▶ Protective window
- ▶ Air purge collar
- ▶ Software CompactConnect
- ▶ USB Kit

Accessories thermoMETER CS / CSmicro / CX

Mechanical accessories CS / CSmicro

Art. No.	Model	Description
2970279	TM-FB-CS	Mounting bracket, fixed
2970280	TM-AB-CS	Mounting bracket, adjustable
2970281	TM-MB-CS	Mounting bolt with M12x1 thread
2970282	TM-MG-CS	Mounting fork, adjustable in 2 axes, with thread M12x1
2970283	TM-AP-CS	Air purge collar for 10:1 sensors
2970284	TM-APL-CS	Air purge collar, laminar
2970285	TM-APLCF-CS	Air purge collar, laminar, integrated CF-lens
2970286	TM-RAM-CS	Right angle mirror for 90°C measurements
2970287	TM-USBK-CS	USB interface kit incl. software CompactConnect

Optical accessories CS / CSmicro

2970277	TM-CF-CS	CF-Lens for CS series
2970278	TM-PW-CS	Protective window for CS series

Calibration CS / CSmicro

2970288	TM-CERT-CS	Certificate of calibration
---------	------------	----------------------------

Mechanical accessories CX

Art. No.	Model	Description
2970307	TM-AP-CX	Air purge collar, aluminium (anodized)
2970321	TM-FB-CX	Mounting bracket, adjustable in one axis, stainless steel
2970322	TM-AB-CX	Mounting bracket, adjustable in two axes, stainless steel
2970311	TM-USBK-CX	USB-Kit: USB programming adapter, Software CompactConnect

Optical accessories CX

2970302	TM-CF-CX	CF-lens for thermoMETER CX
2970303	TM-PW-CX	Protective window for thermoMETER CX

Calibration CX

2970323	TM-CERT-CX	Certificate of calibration
---------	------------	----------------------------

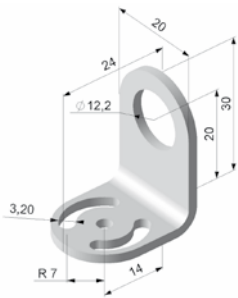

TM-FB-CS Mounting bracket, fixed

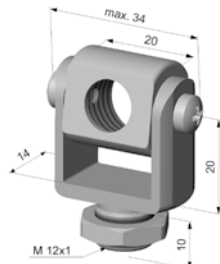

TM-MG-CS Mounting fork with M 12x1 thread adjustable in two axes

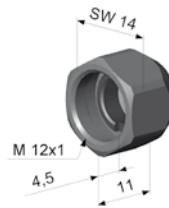

TM-CF-CS Close Focus Lens (LT sensors only)

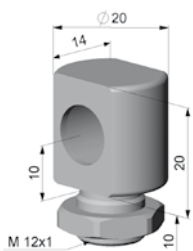

TM-MB-CS Mounting bolt with M12x1 thread adjustable

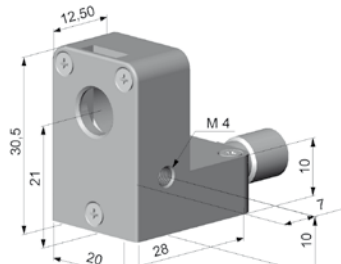

TM-APL-CS Air purge collar

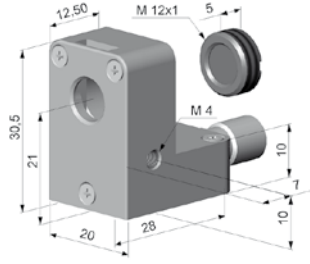

TM-APLCF-CS Air purge collar, laminar, integrated CF-lens



TM-APL-CS Laminar air purge collar and TM-MG-CS Mounting fork

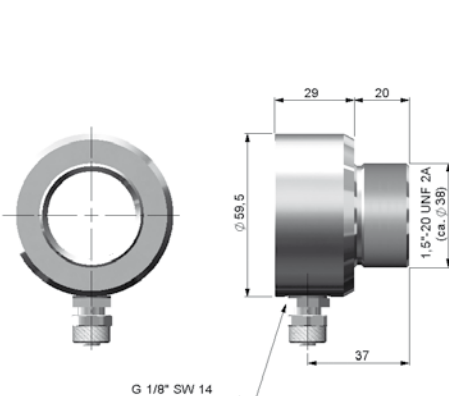

TM-AP-CX Air purge collar CX sensors

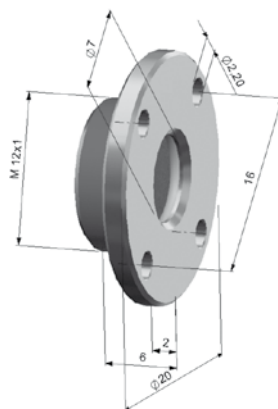

TM-CF-CX CF-Lens
TM-PW-CX Protective window



TM-RAM-CS Right angle mirror

